

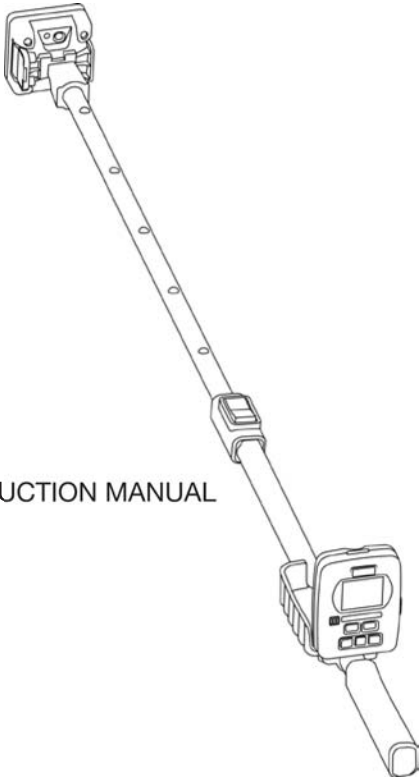

ReachMaster Pro

BLD5777



INSTRUCTION MANUAL

Amphenol
Advanced Sensors

INS5777_EN Rev. B
04/2020

Contents

Quick Start Guide

Sensor and Display Display Module4

1. Introduction.....5

1.1 Display Module.....5

1.1.1 Display Module Battery Replacement & Installation 6-7

1.2 Sensor Module 7-8

1.2.1 Battery & Abrasion Plate Replacement 8-10

2. Safety Considerations.....10

3. Product Components and Accessories: 10-11

4. Starting the Device (Turning ON and OFF):12

5. ReachMaster Pro Modes 13-16

5.1 Measurement Mode14

5.2 Feature Settings14

5.2.1 Changing Language14

5.2.2 Changing Brightness15

5.2.3 Buzzer ON-OFF:15

5.2.4 Setting Auto Off Time:15

5.2.5 Sensor S.I.NO:15

5.2.6 Calibration16

5.2.7 About16

6. Care and Maintenance16

7. Technical Specifications:17

7.1 Operating Conditions:17

7.2 Measurement Specifications:17

7.3 Physical Specifications:17

7.3.a Power for sensor module17

7.3.b Power for display module17

7.3.c Gross weight17

7.4 Regulatory Compliance:17

7.5 User interface:17

7.5.a Display17

7.5.b Application profiles17

Quick Start Guide





ReachMaster Pro has a sensor unit and display unit assembled on a telescopic handle for remote access.

Before getting started, the sensor module and display module should be turned ON. For this, pull off the battery insulator assembled as a first step from both the sensor and display modules.

Sensor Module

- a. Power ON Key : Press this Key to turn the sensor module on.
- b. Status LED: A multi-color LED is provided to indicate the state of the sensor unit.

Display Module

- a. Power ON Key 
 - i. Press this key to turn the display unit on.
 - ii. The same key is also used as an Enter option, and to make selection from the menu.
- b. Settings Key : To change the device configuration, press this key to go to Settings Menu.
- c. Up/Increment Key :
 - i. Press this key to navigate through the user menu in Settings.
 - ii. The same key is also used to increase the increment of the sensitivity scale in the measurement screen.
 - iii. When in measurement mode, press and hold for 2 seconds to enable sensitivity.
- d. Down/Decrement Key 
 - i. Press this key to navigate through the user menu in Settings.
 - ii. When in measurement screen, the same key is also used to decrease the increment of the sensitivity scale
 - iii. When in measurement mode, press and hold for 2 seconds to enable sensitivity..
- e. Ref/Hold/Back Key :
 - i. When in the measurement screen, press and hold for 2 seconds to enter Ref Mode.
 - ii. Press to freeze/unfreeze reading in the measurement screen.
 - iii. Press to go back to the previous menu when in settings/ref screen.

1. Introduction

The Protimeter ReachMaster Pro is a non-invasive moisture measurement device placed on an extendable pole to enable easy access to remote areas. The sensor unit is mounted on the tip of the telescopic pole, communicates with the display unit mounted close to the handle with a docking arrangement.

1.1 Display Module

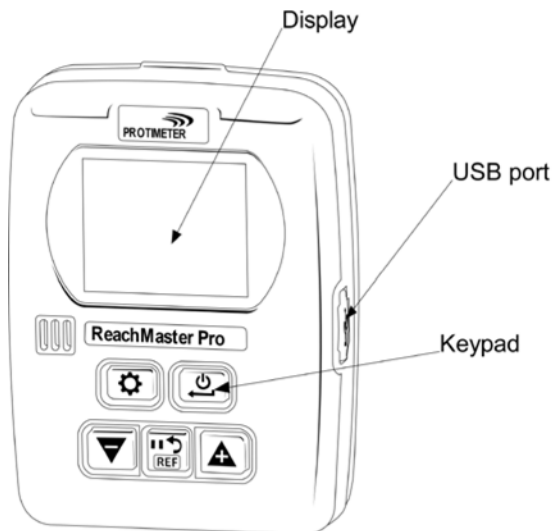

The display unit has a 2" screen to display the measurements from the sensor unit.

A USB port is available to allow the user to update device software in the field, whenever there is an update available. An off-the-shelf USB mini-B cable can be used for the upgrade.

For notification of software updates, please register your ReachMaster Pro at www.registeryourmeter.com.

The keypad on the display allows the user to easily change the sensitivity while in measurement.

1.1 Display Module (cont.)

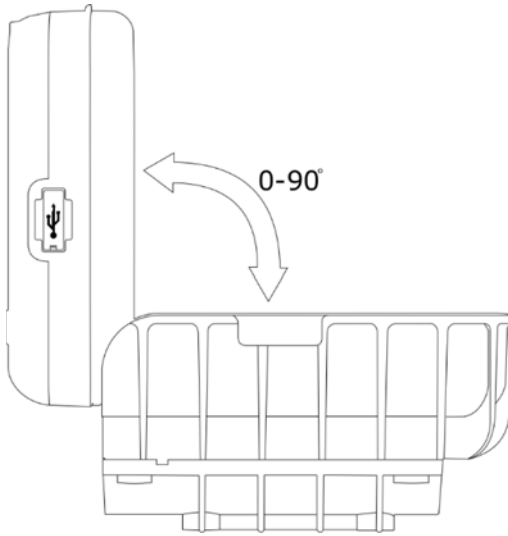

The display unit can be angularly adjusted from 0° to 90° for better viewing experience during measurement.

1.1.1 Display Module Battery Replacement & Installation

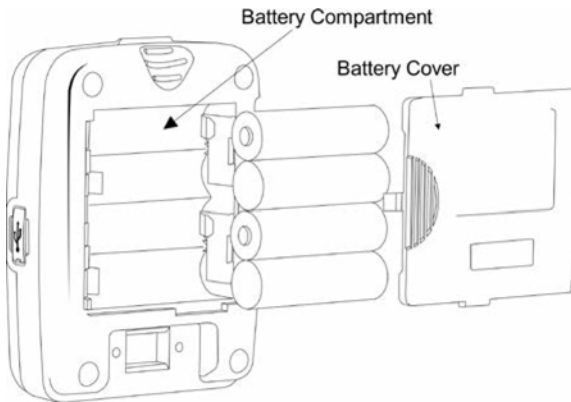

1.1.1 Display Module Battery Replacement (cont.)

4 X AA 1.5V alkaline batteries are to be installed in the battery compartment at the back of the device as shown in the above figure. Polarities are marked in the battery compartment. Care needs to be taken to install the batteries in the right direction according to the markings. Replace the battery cover after installation.

1.2 Sensor Module

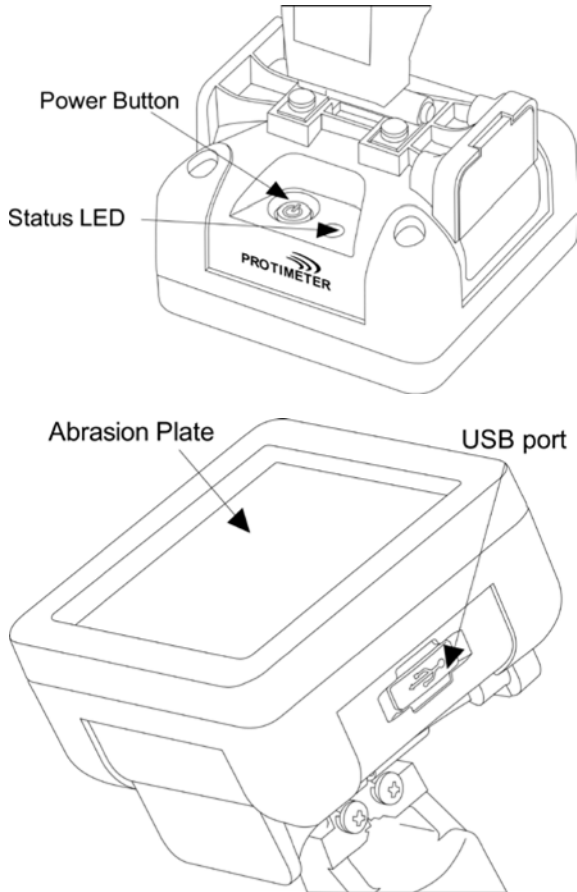

1.2 Sensor Module (cont.)

The sensor unit can be turned ON using the power button, as shown in the above figure. The sensor unit automatically turns off when the battery is low, or when it is not connected to display unit for more than 2 minutes or if the connected display unit is turned off.

The status LED turns red to indicate the battery low condition. Once the low battery is indicated, the user needs to replace the battery as soon as possible; otherwise, the sensor will turn OFF automatically.

A USB port is available to allow for software upgrades. A USB mini-B cable can be used for upgrading, as with the display unit. Once the program is loaded, remove the battery cover and disconnect the batteries to restart the unit.

For notification of software updates, please register your ReachMaster Pro at www.registeryourmeter.com.

Sensing area is built with an abrasion plate, which can be replaced when worn out. Wear-out indication is provided for every 0.5mm. It is advised to replace the abrasion plate when the 1mm mark is reached. The user may continue to use the device with the same abrasion plate based on the application.

1.2.1 Battery & Abrasion Plate Replacement

The sensor module is powered with 2 X AA 1.5V alkaline batteries. Units are shipped with batteries installed.

To replace the batteries, remove the screws to open the battery compartment.

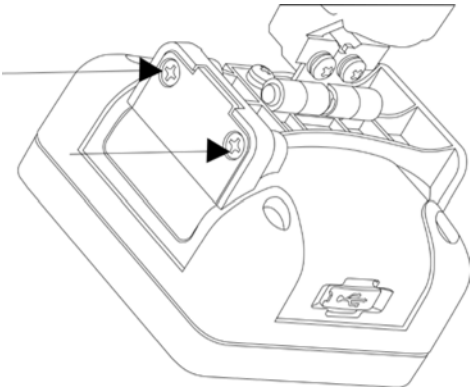

1.2.1 Battery & Abrasion Plate Replacement (cont.)

Replace the batteries, looking at the polarity markings provided on the battery cover, and then close the cover with the screws.

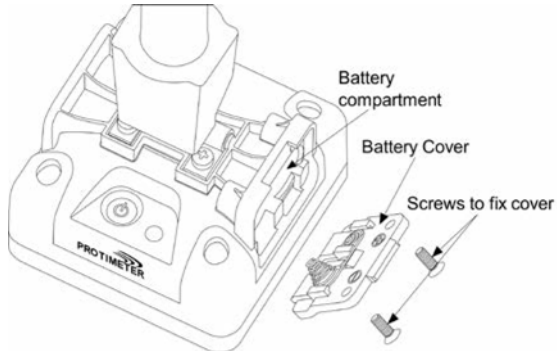

The abrasion plate should be replaced when 1mm mark is reached. Four screws need to be removed to replace the abrasion plate, as shown below.

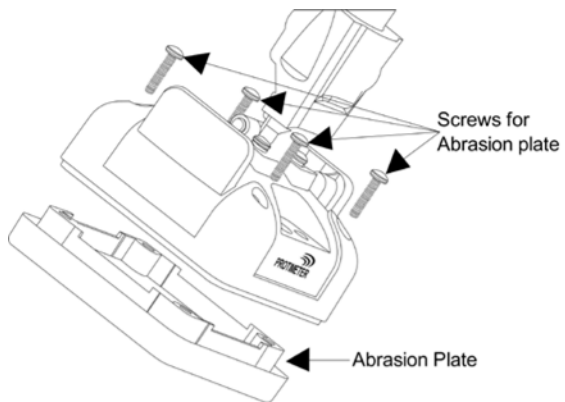

1.2.1 Battery & Abrasion Plate Replacement (cont.)

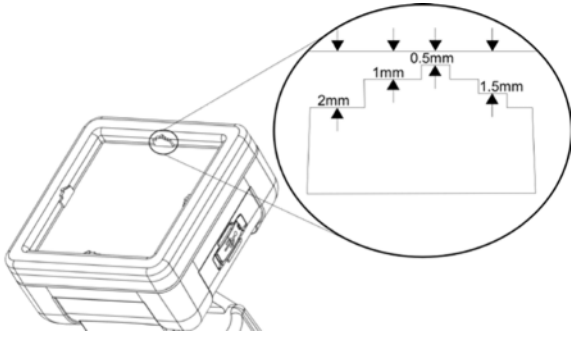

2. Safety Considerations

- ▶ **Battery:** Do not charge the battery, as the supplied batteries are primary alkaline cell. Also, dispose of the batteries according to practices recommended by the battery manufacturer.
- ▶ **Calibration:** It is recommended to calibrate the device on each use to adapt to the measuring environment.
- ▶ **Battery Replacement:** Use recommended batteries for replacement.



3. Product Components and Accessories:

Protimeter ReachMaster Pro has a replaceable abrasion pad, which can be purchased separately when worn out.

3. Product Components and Accessories (cont.)

Protimeter ReachMaster Pro has a replaceable abrasion pad which can be purchased separately when worn out.

Below is a list of spare parts that can be ordered separately:

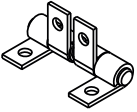
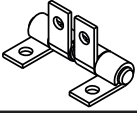
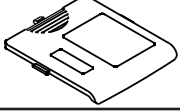
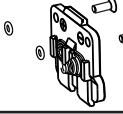
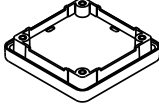
Part No.	Description	
BLD5777-D	Display Unit (with screws)	
BLD5777-S	Sensor Unit (with screws)	
BLD5777-P	Extension Pole	
BLD5777-HD	Hinge for Display (with screws)	
BLD5777-HS	Hinge for Sensor (with screws)	
BLD5777-D-CAP	Battery Cap for Display	
BLD5777-S-CAP	Battery Cap for Sensor	
BLD5777-A	Abrasion Plate Kit (with screws)	



4. Starting the Device (Turning ON and OFF):

Prior to initial use, ensure that the battery insulators are pulled off.

Note: *The battery status is indicated on the display unit (for both sensor and display units). When low battery is indicated, replace the batteries.*

To switch ON, press the power button  on both the sensor and display units.

Switch the sensor unit ON and look for LED indications. LED indication starts with green, and then turns to blue during initialization. Once initialized, the LED will blink blue for every second, indicating that the sensor is turned on and is waiting for connection to the display unit. Once the sensor unit is turned on and initialized, turn the display unit on.

The display unit goes to the measurement mode by default. Once the display unit is turned ON and initialized, the connectivity symbol  can be seen blinking. This means that the connectivity is not established yet. When connected, the connectivity  symbol will stop blinking. Now, the device is ready for use. If the sensor is placed on a surface, the display unit will display the reading that the sensor unit measures.

5. ReachMaster Pro Modes

The Protimeter ReachMaster Pro is used to scan the roof and floor for moisture in different materials.

5.1 Measurement mode:



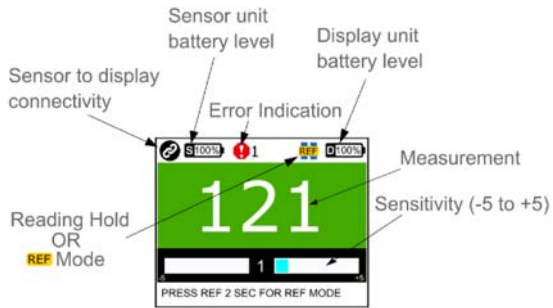

Measurement Mode is the default mode while the device is turned ON.

The measured value will be displayed on the screen in this mode, and the background color and beeper will change to indicate the moisture level.

Measurement	Display	Indication	Progress Bar
<60	---		
≤60 but <170	Non-Invasive value	DRY	GREEN
≥170 but <200	Non-Invasive value	RISK	YELLOW
≥200 but <999	Non-Invasive value	WET	RED
≥999	999	WET	RED



5.1 Measurement Mode (cont.)

A special feature to change the measurement sensitivity helps the device measure better in different materials. Press and hold  or  while in measurement for 2 seconds to enable the sensitivity keys. Once the sensitivity is enabled, an indication  will be seen on screen. Press either  or  to increase the sensitivity or to decrease the sensitivity, based on need after enabling the sensitivity.



Example: To zero in on the wettest areas to find the source of moisture, decrease the sensitivity to extend the measurement range.

If a comparison needs to be made on surfaces, the reference mode can be used. During measurement, press and hold the  for 2 seconds to allow the unit to enter reference mode, taking the current measurement as the base. Further measurement will be a comparison from the base.







Example: To compare a known dry area with other areas in the building, take a reference reading from the dry area and compare the new readings without having to manually record the referenced dry reading.

5.2 Feature Settings





ReachMaster Pro provides an option to enable, disable or change features like, including buzzer, display brightness, data transmission rate, etc. At any point of time when the unit is turned ON, if the  button is pressed, the unit will enter the Settings screen.

If any setting needs to be changed or adjusted, the function/parameter can be selected by scrolling through the menu using  or  and then pressing .



5.2.1 Changing Language

In the Settings menu, select LANGUAGE by navigating with  or  keys. Press  to select the language (language will be highlighted). Change the language using  or  keys and when the desired language is highlighted, press  to select it.



5.2.2 Changing Brightness

The backlight brightness can be increased or decreased by selecting the Brightness menu and pressing . Brightness can be changed in 10 levels using  or  key. Press  to confirm and exit.

5.2.3 Buzzer ON-OFF:





The user can turn the buzzer ON or OFF based on the need. If the user needs an audible indication for each key press, or during different functionality switching, the buzzer should be turned ON. This can be done by entering the edit mode and then using  or  keys.

5.2.4 Setting Auto Off Time:

The user can set the time to automatically turn OFF if the device in idle condition. This can be set in minutes. A maximum of 6 minutes can be set for the device to turn off in idle condition. To do this, enter edit mode, as mentioned earlier, and use  or  keys to change the Auto OFF Time.

5.2.5 Sensor SI.NO:

This is a factory set parameter. The sensor module in the device is paired with the display unit with the serial number entered here. This is only changed if the sensor module alone in the device is changed for some reason, which is a rare scenario. If user has not changed the sensor module in field, it is better not to enter into this menu.



SI. No can be entered by changing each digit using  or  key and pressing  to confirm and jump to the next digit. Once the last digit is set, it will automatically go back confirming the serial number. In the middle of setting this number if  is pressed, this setting will not be applied.

5.2.6 Calibration

The unit can be calibrated for every use to adapt to the required environment. Look for instructions on the screen during calibration and follow the same.

5.2.7 About

About provides information related to the device, such as model number, paired sensor details, firmware versions, calibration status, etc.

There are two pages in the screen that can be accessed by pressing  and .

6. Care and Maintenance

The Protimeter ReachMaster Pro is a remote moisture measurement system that will provide many years of reliable service if the following points are observed:

- ▶ When not in use, keep the ReachMaster Pro instrument in the package provided. Store the package in a stable, dust-free environment, and keep it out of direct sunlight
- ▶ If the instrument is to be stored for more than four weeks, or if the low battery power symbol appears on the display, remove the batteries from the instrument.
- ▶ Check the condition of the ReachMaster Pro abrasion plate on a regular basis, and replace them if they become worn or damaged. The abrasion plate has markings to indicate the level of wear-out. It is recommended to replace the plate once wear-out reaches 1mm marking.

7. Technical Specifications:

7.1 Operating Conditions:

Temperature: 0°C to 50°C

RH: 0 to 95% non-condensing

7.2 Measurement Specifications:

Non-invasive moisture measurement:

Measurement depth: minimum of 70mm (increases with material specification)

Reading: instantaneous reading 60 to 999ppm, surface moisture is not adversely affected.

7.3 Physical Specifications:

7.3.a Power for sensor module

Batteries: 1.5V X 2 Alkaline ~ 2700mAH

Battery level indication on Display unit and a battery low LED indication on Sensor unit.

7.3.b Power for display module

Batteries: 1.5V X 4 Alkaline ~ 2700mAH

Battery level indication on display.

7.3.c Gross weight

Instrument only: 24.7oz (700g)

7.4 Regulatory Compliance:

CE, RoHS, ETL

7.5 User interface:

7.5.a Display

Graphical LCD

Size: 2"

Resolution: 176 X 220

Backlight (with adjustable brightness)

7.5.b User application profiles

Sticky memory last used application settings

Customer Support:

U.S.A.

Amphenol Thermometrics, Inc.
967 Windfall Road
St. Marys, Pennsylvania 15857, USA
T: +1 814-834-9140

U.K

Amphenol Thermometrics (U.K.) Limited
Crown Industrial Estate Priorswood Road
Taunton, TA2 8QY, UK
T: +44 1823 335 200

www.protimer.com

www.amphenol-sensors.com

Amphenol
Advanced Sensors

©2020 Amphenol Thermometrics, Inc. All rights reserved.
Technical content subject to change without notice.

INS5777 Rev B
04/2020